



FROM CONCEPT TO USER

LRPC104

Rear Bumper

Land Rover

Technical Data

Material	Steel S275JR EN10025-2
Thickness	3 mm
Finish	Textured Black Powder Coating

Vehicle Compatability

Land Rover Discovery I 200Tdi

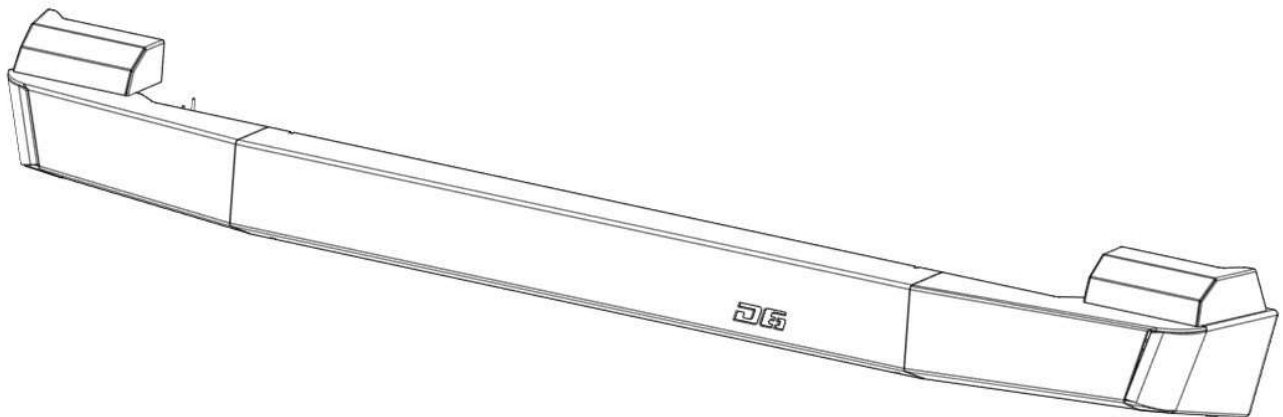

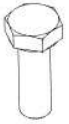
Checklist:

M6x20

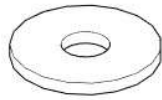
 6x

M6 wide brim

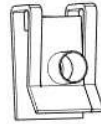
 6x

M6

 6x

M10x25

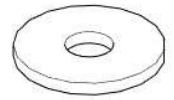
 2x

M10 wide brim

 2x

M8x20 conical

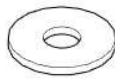
 2x

M8

 2x

M8

 2x

Rivet 5x16

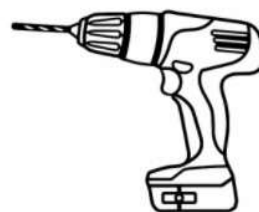
 6x**Tools required:** 10, 17 5 Ø 6

Fitting instructions: